

WHEN QUALITY MEETS BEAUTY
COLD FINDS ITS PERFECT PROFILE



COLD
SYSTEM

EXCELLENCE SINCE 1955

**ELEVATI STANDARD
QUALITATIVI**
TOP QUALITY STANDARDS

MONTAGGIO RAPIDO
QUICK MOUNTING CAPABILITY

ROBUSTEZZA
RUGGED STRUCTURE

**FUNZIONALITÀ ED
ECONOMICITÀ**
FUNCTIONALITY AND
ECONOMY

ALTO LIVELLO SANITARIO
HIGH SANITARY LEVEL

LOMBARDINI produce profili e stampati, standard e personalizzati per le seguenti applicazioni: refrigerazione industriale, settore alimentare e sanitario.

La gamma di prodotti comprende: profili angolari, profilo battiscopa, basi pavimento, profili per pannelli, profili per telaio e per porte, profili porta guarnizioni, bumpers, profili porta prezzi e guarnizioni.

I prodotti Lombardini sono Made in Italy e realizzati con resine termoplastiche certificate di prima qualità, in classe V0 norma UL94.

LOMBARDINI manufactures profiles and injection moulded products, standard and custom for following applications: industrial refrigeration, food and sanitary applications.

The product range includes: covings profiles, rounded plinth profile, U channel profiles, profiles for panels, for frame and for doors, strip-holding profiles, bumpers, price holders profiles and gaskets.

Lombardini's products are totally Made in Italy and realized with certified thermoplastic resins of first quality, in class V0 UL94.

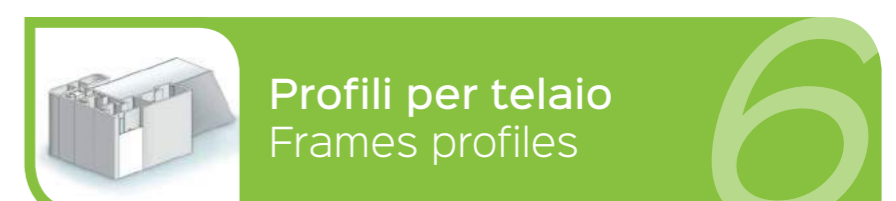
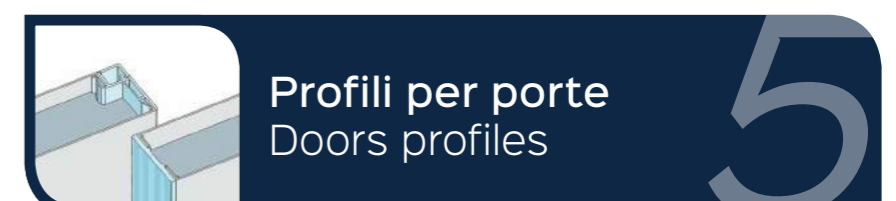
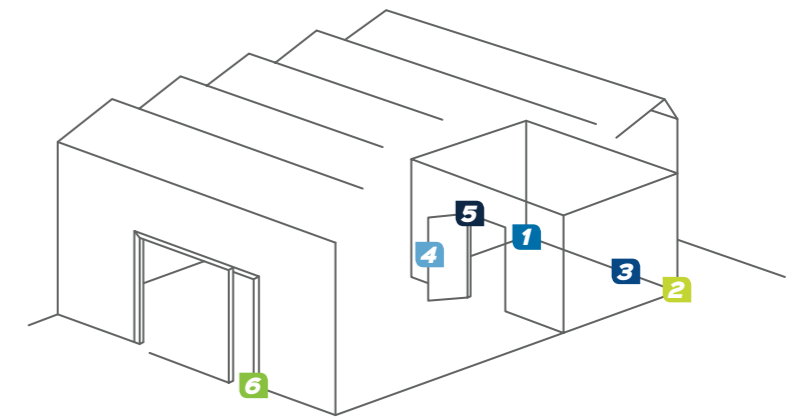



PROFILI ANGOLI SANITARI COVINGS SANITARY PROFILES

Sono dotati di un supporto in resina termoplastica o in alluminio per consentire fissaggi strutturali tra pareti, soffitti e pavimenti. I profili sono completi di particolari stampati che consentono un rapido assemblaggio ed una efficace finitura.

I modelli dotati di ali morbide garantiscono altissimi livelli di igiene.

Provided with supports of thermoplastic resin or aluminium to allow fixing between walls, ceiling and floor. The profiles are also equipped with plastic elements for quick mounting and finishing.

Models with soft edges ensure top sanitary level.

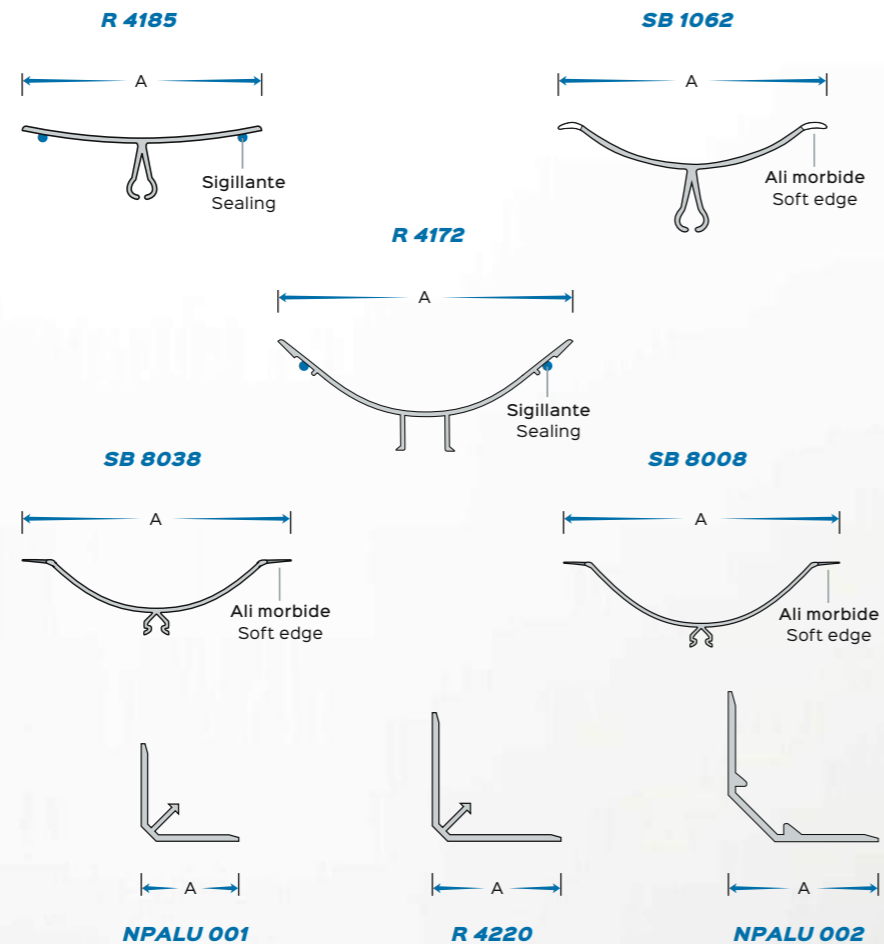

USI Celle frigorifere, ambienti alimentari, ospedali, laboratori, camere bianche.
USES cold rooms, food sphere, hospital, labs, clean rooms.

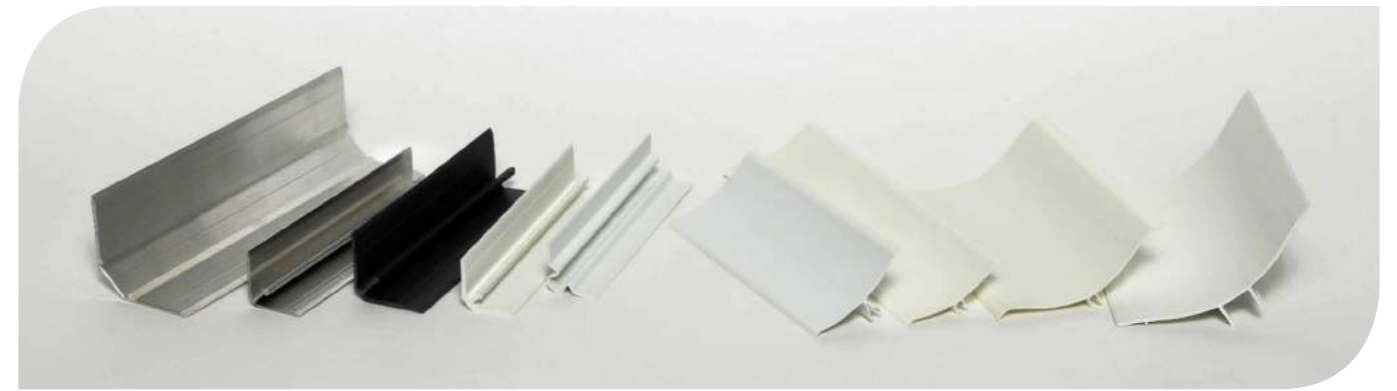

RACCORDI CORNER CAPS

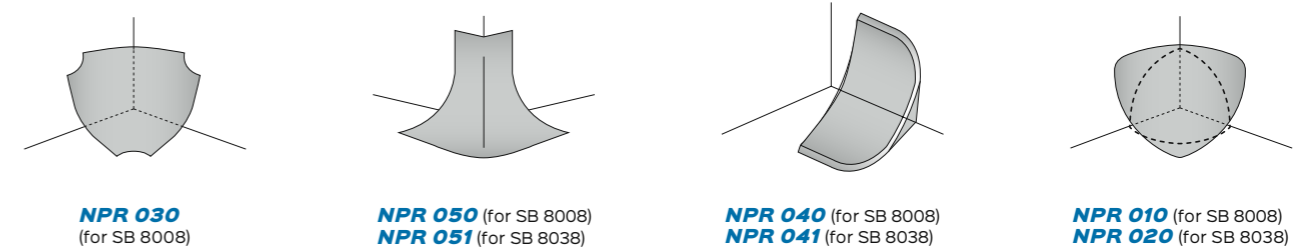

ARTICOLO ITEM	A mm	CONFEZIONI PACKAGING	MATERIALI MATERIALS	LUNGHEZZA LENGTH mm	COLORI COLORS	
R 4170	30	25 pz / pcs	PVC	Standard 4000	Standard RAL 9010 RAL 9002	
R 4172	110	125 pz / pcs	PVC			
R 4184	30	50 pz / pcs	PVC			
R 4185	50	250 pz / pcs	PVC			
R 4220	40	25 pz / pcs	PVC			
SB 1062	60	25 pz / pcs	PVC			
SB 8008	100	25 pz / pcs	PVC			
SB 8038	60	50 pz / pcs	PVC			
NPALU 001	30	25 pz / pcs	Aluminium			
NPALU 002	50	100 pz / pcs	Aluminium			
NPR 010	Raccordo angolo per / Corner cap for: SB 8008		25 pz / pcs			PP
NPR 020	Raccordo angolo per / Corner cap for: SB 8038		25 pz / pcs			PP
NPR 030	Raccordo angolo grande per / Big corner cap for: SB 8008		25 pz / pcs			PP
NPR 040	Raccordo angolo laterale (DX,SX) per / Lateral Corner cap (R,L) for: SB 8008		25 pz / pcs			PP
NPR 041	Raccordo angolo laterale (DX,SX) per / Lateral Corner cap (R,L) for: SB 8038		100 pz / pcs			PP
NPR 050	Raccordo angolo esterno per / External Corner cap for: SB 8008		25 pz / pcs	PP		
NPR 051	Raccordo angolo esterno per / External Corner cap for: SB 8038		25 pz / pcs	PP		



PROFILO BATTISCOPA SANITARIO ROUNDED PLINTH PROFILE

Indispensabili dove sia richiesta, oltre alla tradizionale funzione di battiscopa, una facile sanificazione ambientale e la garanzia delle norme igienico sanitarie vigenti.

La messa in opera è veloce e definitiva e il profilo non presenta elementi di fissaggio a vista.

Il sistema è dotato di accessori che completano la posa del profilo nelle diverse tipologie (angoli interni, esterni, supporti e terminali).

Essential where easy environmental sanitisation and respect for enforced hygienic standards are requested beside the traditional application as plinth profile.

One-off and quick installation is guaranteed and the profile has no visible mounting elements.

The system is equipped with accessories to complete any kind of mounting option (internal and external corner caps, mounting support and terminals).

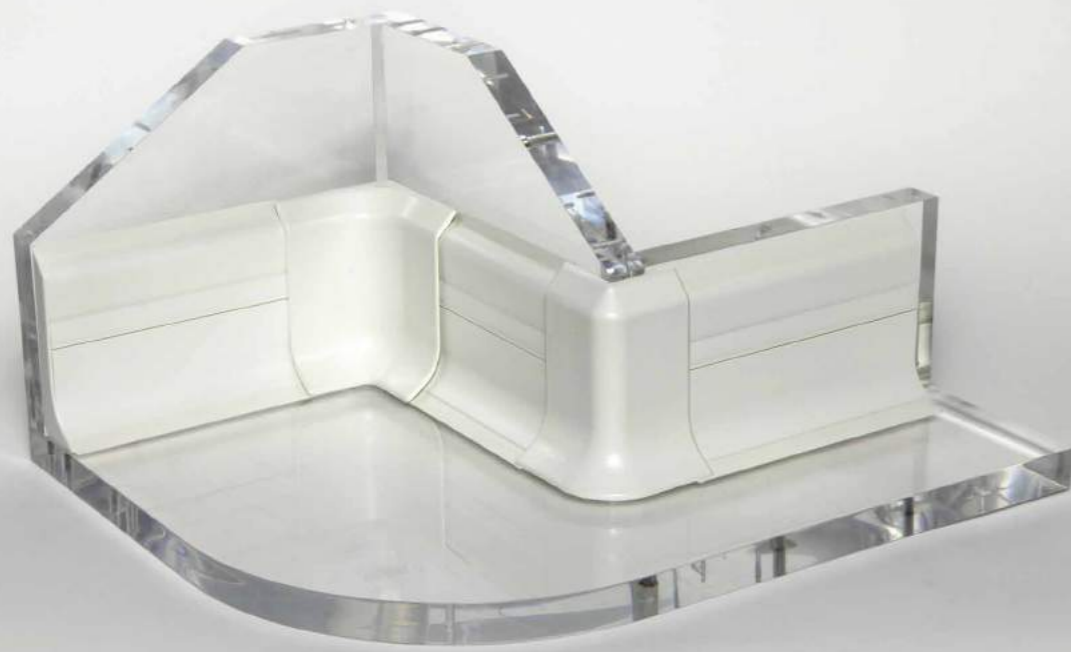
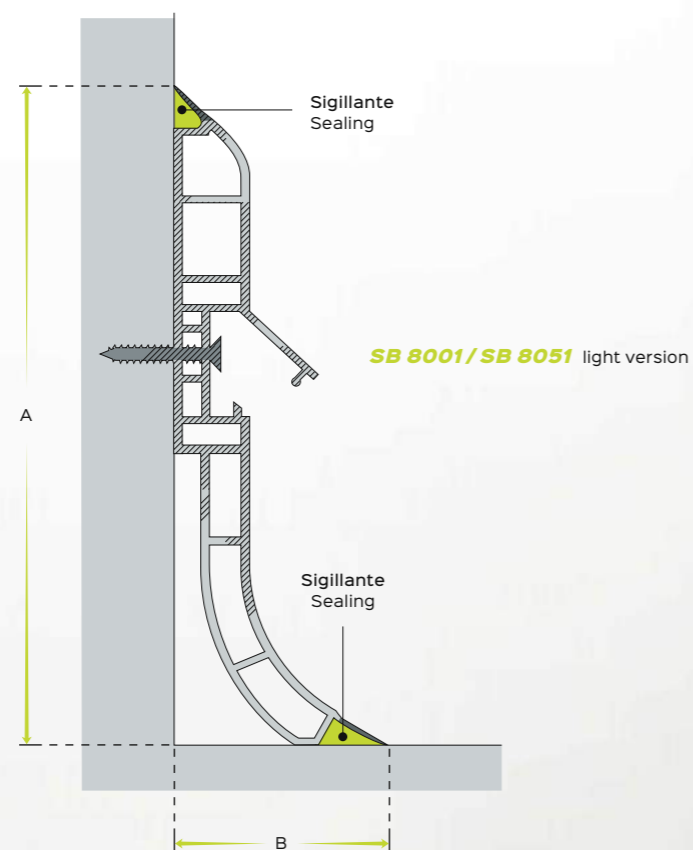

USI Celle frigorifere, ambienti alimentari, ospedali, laboratori, camere bianche.
USES cold rooms, food areas, hospital, labs, clean rooms.

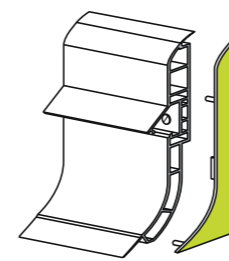
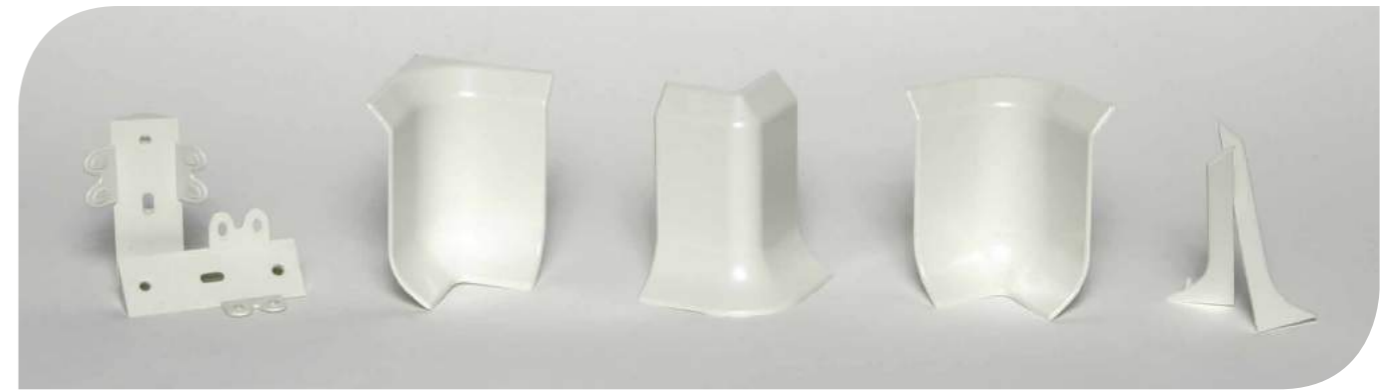

NPR 003 SX

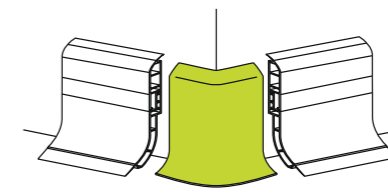

NPR 001

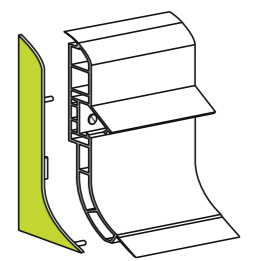

NPR 002 DX

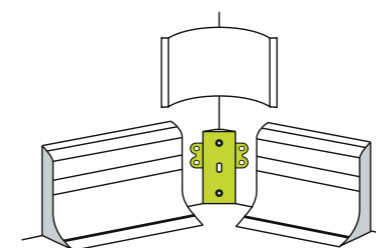

NPR 004

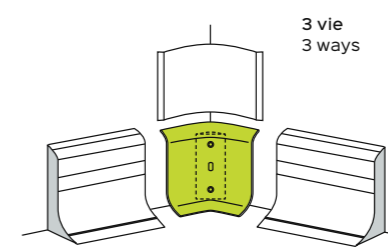

NPR 005

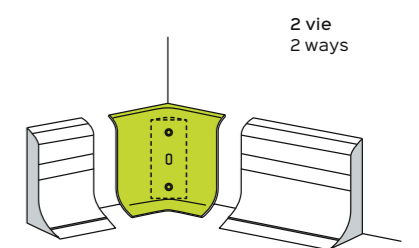

NPR 006

ARTICOLO ITEM	A mm	B mm	LUNGHEZZA LENGTH mm	CONFEZIONI PACKAGING	COLORI COLORS
SB 8001	95	30	4000	15 pz / pcs	Standard RAL 9010 RAL 9002
SB 8051 light version	95	30	4000	15 pz / pcs	
NPR 001	Raccordo angolo esterno / External Corner cap			25 pz / pcs	
NPR 002 DX	Copertura destra / Right cover			50 pz / pcs	
NPR 003 SX	Copertura sinistra / Left cover			50 pz / pcs	
NPR 004	Supporto per NPR 05 - 06 / bracket for NPR 05-06			50 pz / pcs	
NPR 005	Raccordo angolo interno 3 vie / Internal Corner cap 3 ways			25 pz / pcs	
NPR 006	Raccordo angolo esterno 2 vie / External Corner cap 2 ways			25 pz / pcs	



BASI PAVIMENTO U CHANNEL PROFILES

Si utilizzano nella costruzione di ambienti ad atmosfera controllata direttamente collocati su pavimenti esistenti.

Disponibili in quattro versioni:

- semplice (MOD. A);
- pesante con smussi (MOD. B);
- con angolo sanitario di ali morbide (MOD. C);
- con scanalature per una perfetta tenuta a pavimento e angoli arrotondati per un maggior livello sanitario (MOD. D).

Used in manufacture of prefab controlled temperature rooms directly based on existing floors.

Four versions are available:

- simple (MOD. A);
- heavy with bevels (MOD. B);
- with coving provided of soft edges (MOD. C);
- with grooves for a perfect floor-sealing and rounded corners for top sanitary level (MOD. D).

MOD. A

R 4171
R 4124
R 4125
R 4126
R 4127
R 4128



MOD. B

R 4011
R 4047
R 4012
R 4046

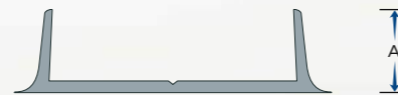

MOD. C

SB 8015
SB 8028
SB 8029
SB 8016



MOD. D

R 4217
R 4193
R 4194
R 4195

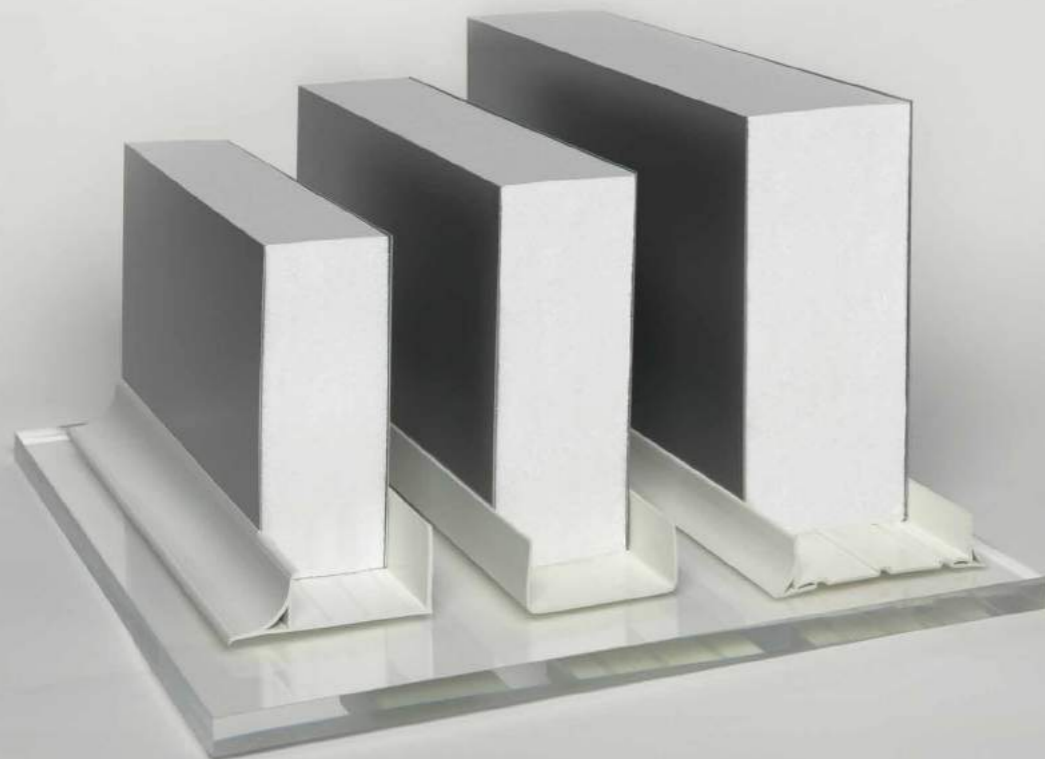

USI Celle frigorifere, ambienti alimentari.
USES cold rooms, food areas.

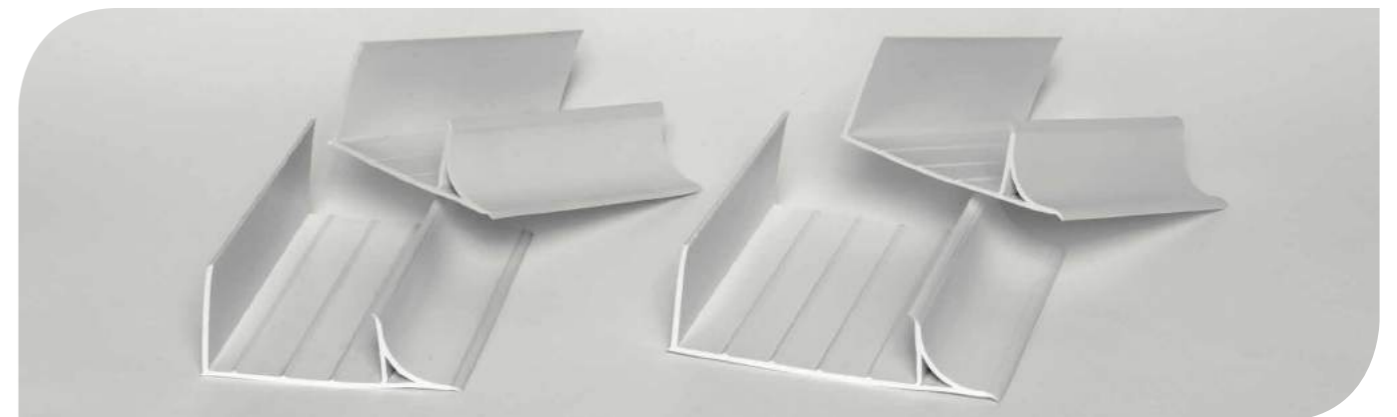
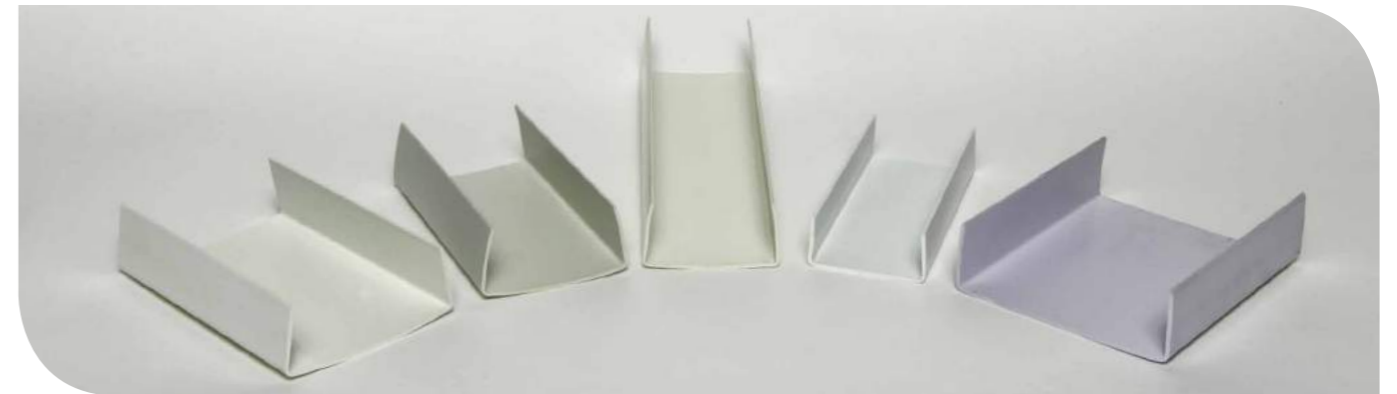

	ARTICOLO ITEM	PER PANNELLI DA mm FOR PANELS OF mm	A mm	LUNGHEZZA LENGTH mm	COLORI COLORS
MOD. A	R 4171	60	30	Standard 4000	Standard RAL 9010 RAL 9002
	R 4124	70	40		
	R 4125	80	40		
	R 4126	100	40		
	R 4127	110	40		
	R 4128	120	40		
MOD. B	R 4011	60	30		
	R 4047	70	28		
	R 4012	80	34		
	R 4046	100	34		
MOD. C	SB 8015	60	36		
	SB 8028	70	36		
	SB 8029	80	36		
	SB 8016	100	36		
MOD. D	R 4217	60	32		
	R 4193	70	32		
	R 4194	80	32		
	R 4195	100	32		



PROFILI PORTA GUARNIZIONE STRIP-HOLDING PROFILES

Si adattano ai diversi stili di costruzione delle porte e contribuiscono ad evitare il ponte termico, prevenendo pericolosi punti di condensa.

Le guarnizioni sono realizzate con materiali a base di gomma termoplastica espansa, resistenti fino alla temperatura minima di -40°C.

Suitable for different building styles of doors, they provide an important contribute to avoid the thermal head, saving from dangerous condense and frost formations.

Gaskets are manufactured with foamed thermoplastic rubber, that can resist till -40°C.

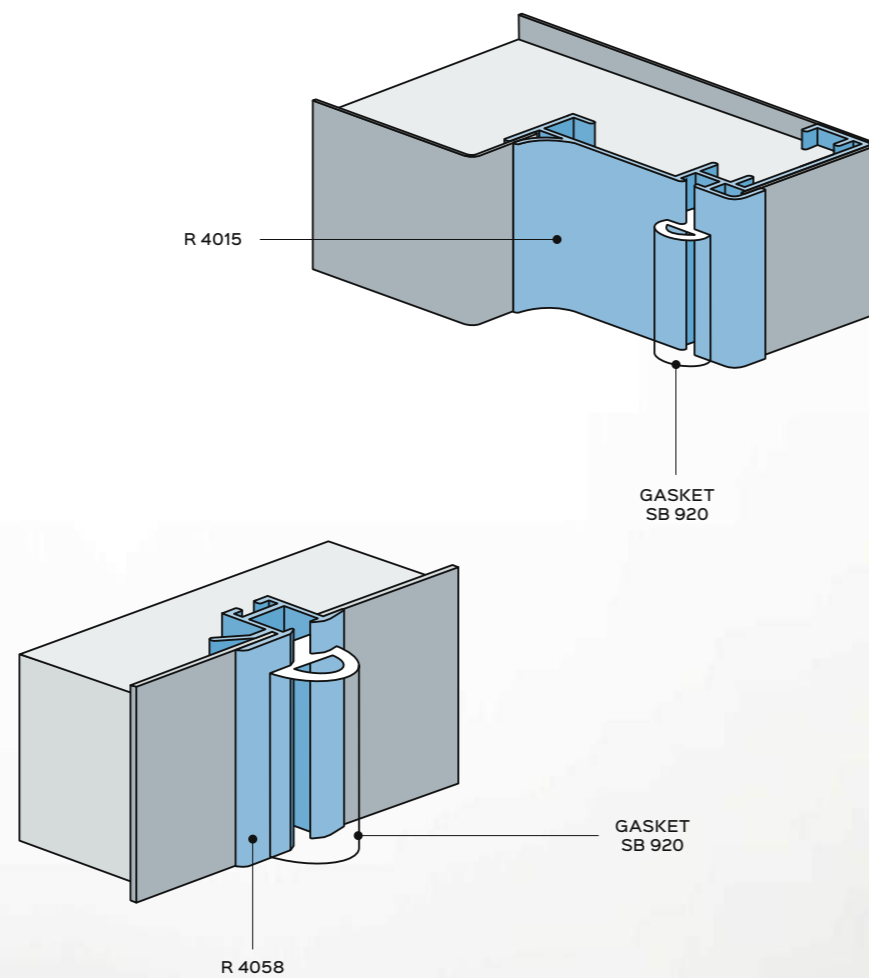

USI celle frigorifere, ambienti a temperatura controllata.
USES cold rooms, controlled temperature rooms.

SB 920 / SB 1065

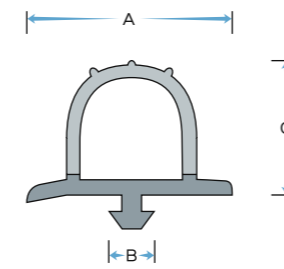

R 4015

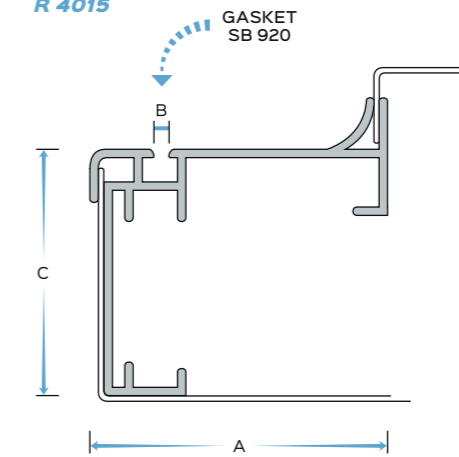

R 4058

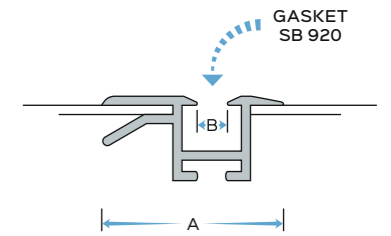

R 4088

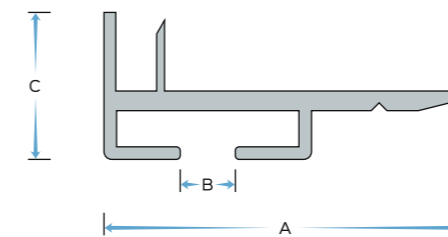

R 4119

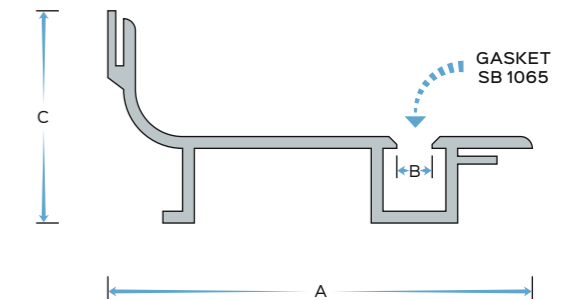

R 4199

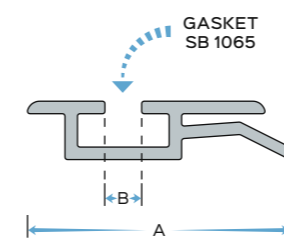

R 4180

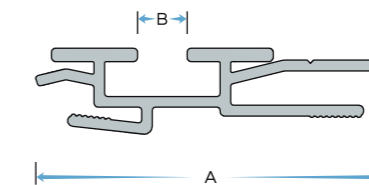

R 4154

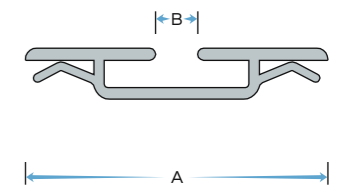

ARTICOLO ITEM	A mm	B mm	C mm	CONFEZIONE PACKAGING	LUNGHEZZA LENGTH mm	COLORI COLORS
SB 920	28	5,8	20	rotoli da 40 m / rolls of 40 m	-	Standard White/Black
SB 1065	28	8	20	rotoli da 40 m / rolls of 40 m	-	Standard White/Black
R 4015	57	3,5	48	-	-	-
R 4058	24	4	-	50 pz / pcs	-	-
R 4088	46	9,5	18,7	25 pz / pcs	-	-
R 4119	54	5	27	30 pz / pcs	Standard 4000	Standard RAL 9010 RAL 9002
R 4199	28,5	4,4	-	50 pz / pcs	-	-
R 4180	47	7	-	40 pz / pcs	-	-
R 4154	41	6	-	25 pz / pcs	-	-



PROFILI PER PORTE DOORS PROFILES

Si utilizzano a completamento e finitura dei tradizionali pannelli coibentati nei vani porta.

In ambienti refrigerati a basse temperature sono ideali i profili con apertura d'ispezione che permette di inserire e/o sostituire la resistenza elettrica necessaria a garantire il taglio termico.

Used to complete and finish traditional insulating panels on door frames.

Profiles with inspection opening, that allows inserting and/or replacing electrical resistance and ensure the thermal break, are recommended in case of refrigerated areas.

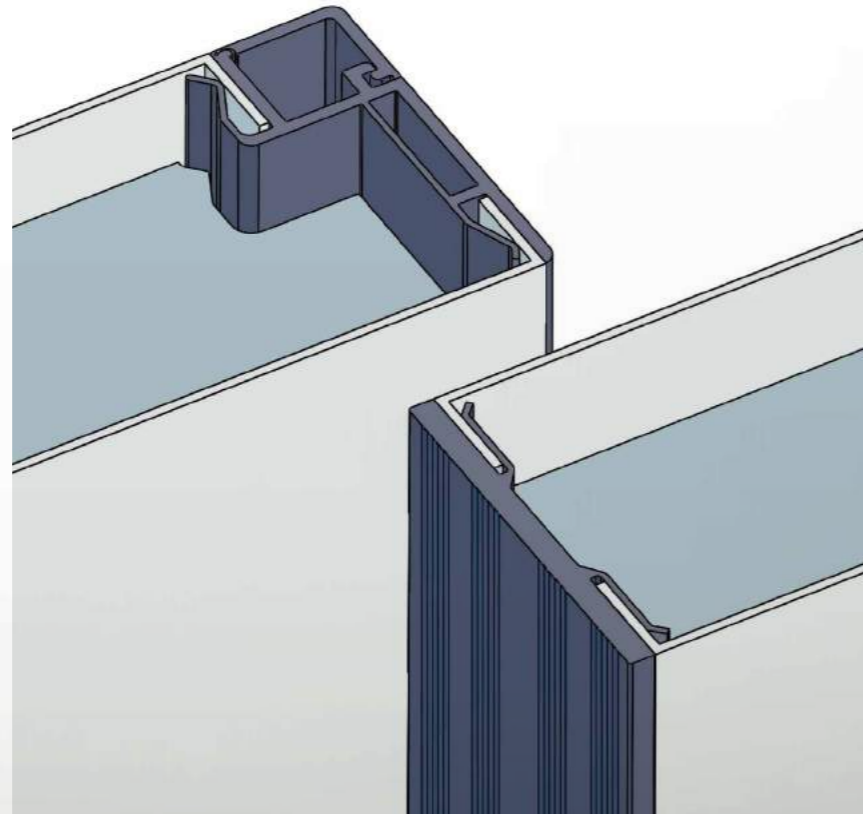

USI celle frigorifere, ambienti a temperatura controllata.
USES cold rooms, controlled temperature rooms.

R 4024
R 4041
R 4042
R 4085

R 4040*
R 4043*
R 4168* } superficie microrigata
microgrooved surface

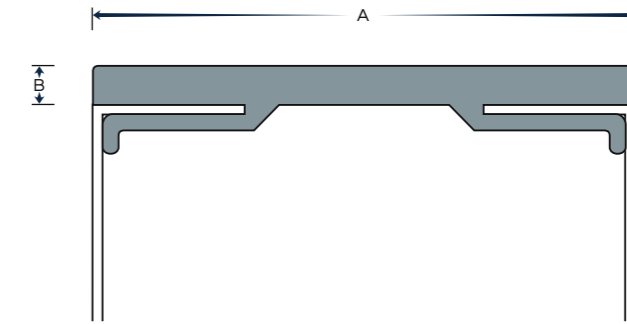

R 4192

Con vano porta-resistenza
With electrical resistance slot

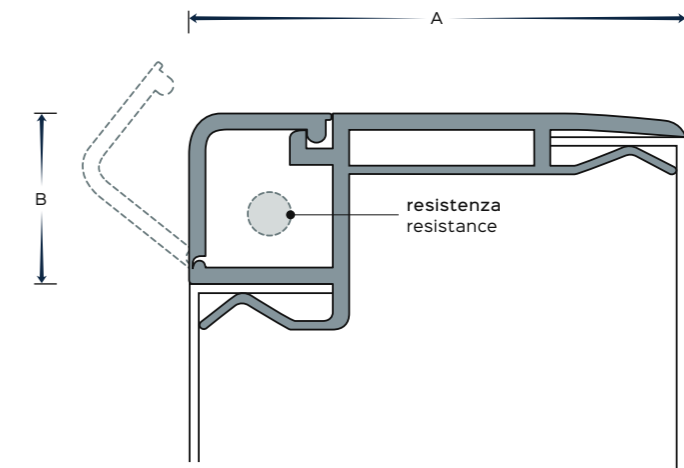

R 4215

Con vano porta-resistenza
With electrical resistance slot

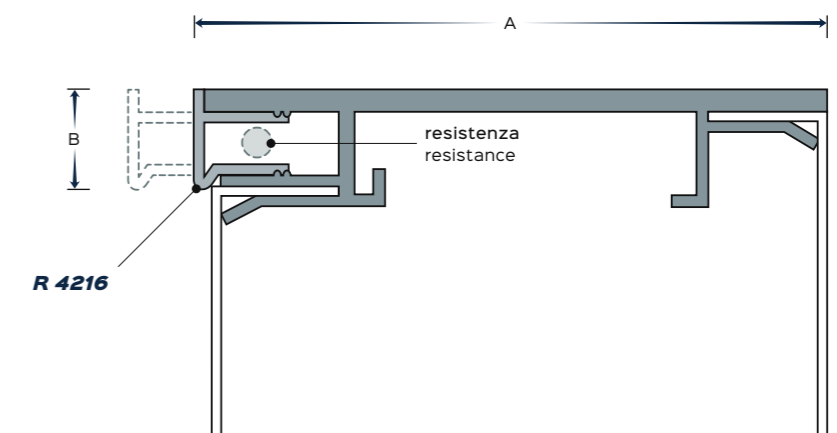

ARTICOLO ITEM	A mm	B mm	LUNGHEZZA LENGTH mm	COLORI COLORS
R 4024	30	1,5	Standard 4000	Standard RAL 9010 RAL 9002
R 4040	90	3		
R 4041	70	3		
R 4042 - R 4043	60	3		
R 4168	80	3		
R 4085	100	3		
R 4192	60	20		
R 4215 / R 4216	80	13		



PROFILI TELAIO FRAMES PROFILES

Sono elementi componibili usati per la costruzione dei telai porte di ogni tipo: a battente e scorrevoli.

Questi telai sono adatti a porte di grandi dimensioni grazie alla robustezza dei suoi componenti.

Are modular system used in the frame construction of various doors: hinged doors, sliding and swing doors.

These frames are suitable for big doors thanks to the thickness of their parts.

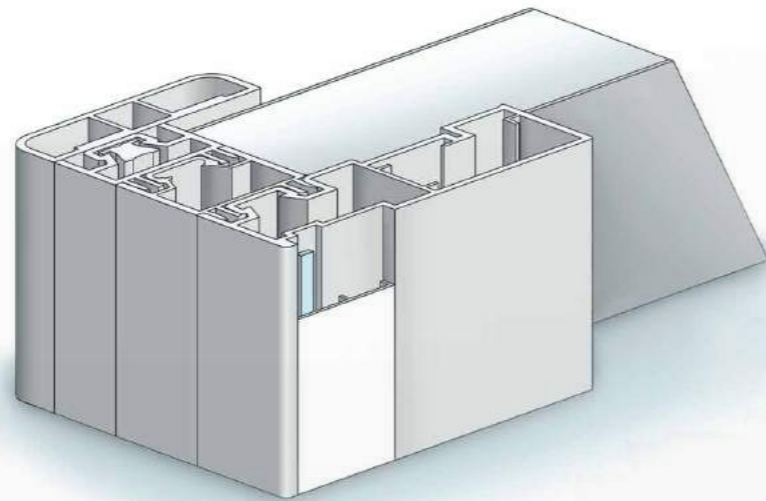

SISTEMA MODULARE
MODULAR SYSTEM

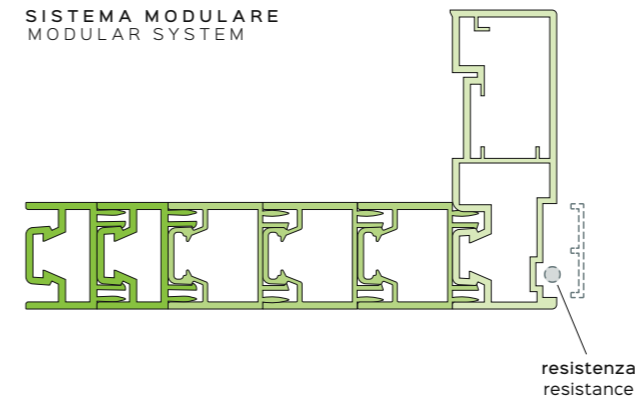

R 4091

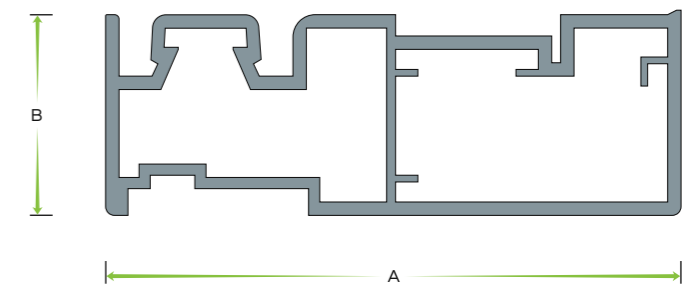

R 4093

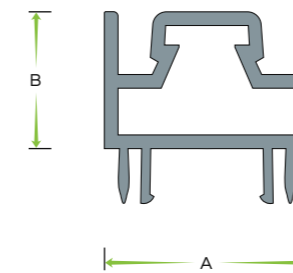

R 4092

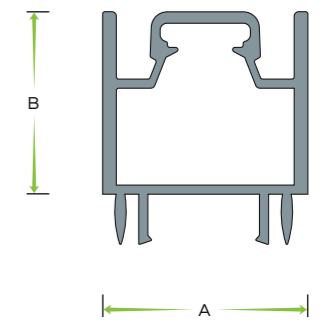

R 4094

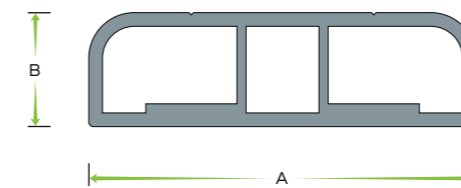

NPALU 003

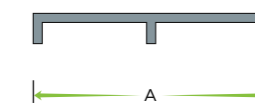

R 4165

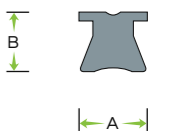

ARTICOLO ITEM	A mm	B mm	LUNGHEZZA LENGTH mm	COLORI COLORS
R 4091	129	45	Standard 6000	Standard RAL 9010 RAL 9002
R 4092	45	40		
R 4093	45	30		
R 4094	85	25		
R 4165	14,8	13		
NPALU 003	38	-		

Profili per pannelli / Profiles for panels

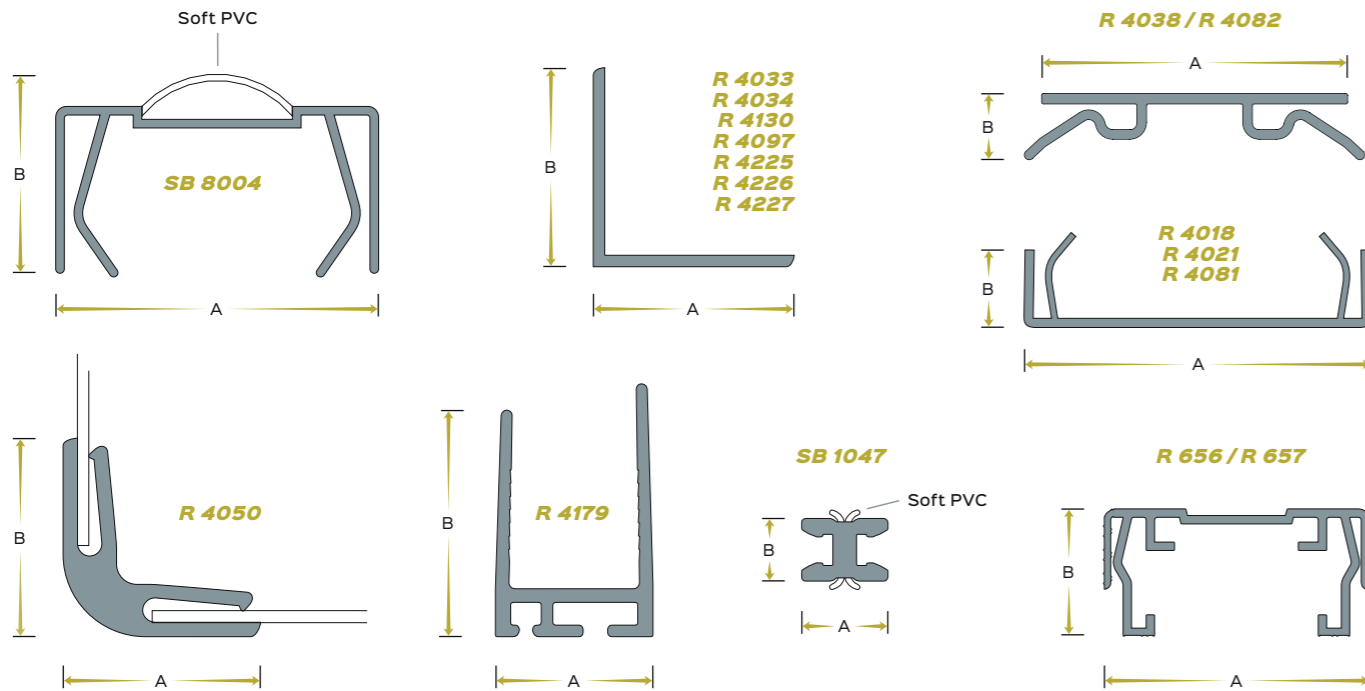

ARTICOLO ITEM	A mm	B mm	LUNGHEZZA LENGTH mm	COLORI COLORS
SB 8004	30	19	Standard 4000	Standard RAL 9010 RAL 9002
R 4018	30	12		
R 4021	40	13		
R 4081	50	9		
R 4033	20	20		
R 4034	30	30		
R 4130	60	60		
R 4097	60	80		
R 4225	60	120		
R 4226	100	100		
R 4227	140	140		
R 4050	19	19		
R 4038	37	8		
R 4082	25	6		
R 4179	24	34		
SB 1047	13	9		
R 656	60	19		
R 657	40	19		

USI celle frigorifere, ambienti a temperatura controllata.
USES cold rooms, controlled temperature rooms.

Sistemi di fissaggio / Fixing system

Viti e rondelle per telai porte, pannelli e soffitti
 Screws and washers for frames doors, panels and ceilings.



VITI / SCREWS

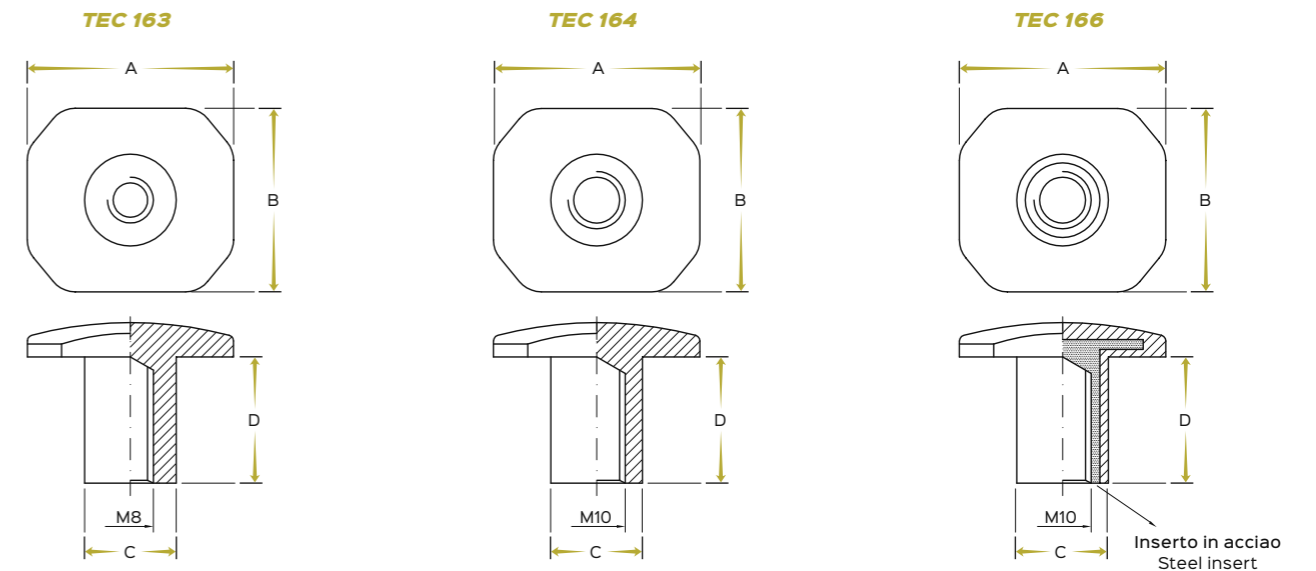

RONDELLE / WASHERS

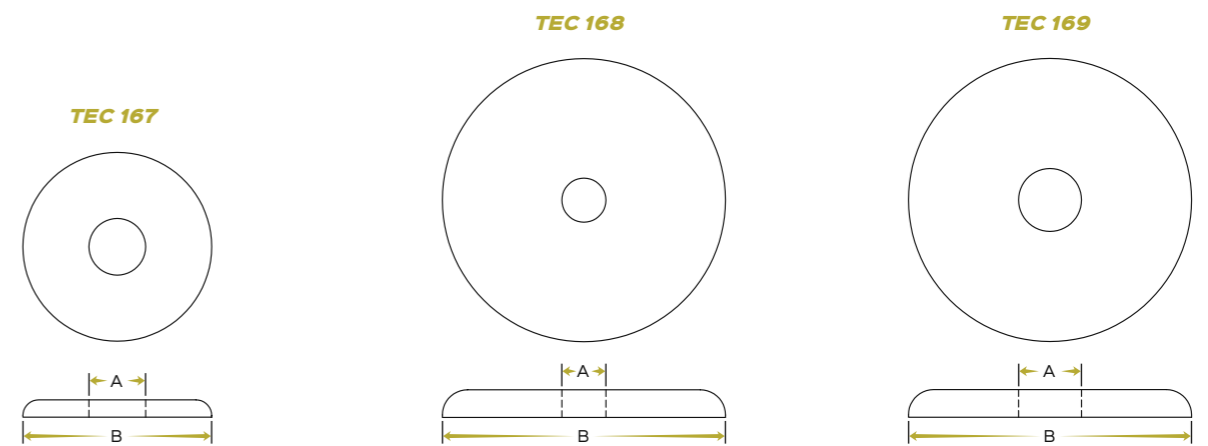

ARTICOLO ITEM	A mm	B mm	C mm	D mm	CONFEZIONI PACKAGING	COLORI COLORS
TEC 163	36	32	16	22	250 pz - pcs	Standard RAL 9010 RAL 9002
TEC 164	36	32	16	22	250 pz - pcs	
TEC 166	36	32	16	22	250 pz - pcs	
TEC 167	18	60	-	-	250 pz - pcs	
TEC 168	14	90	-	-	100 pz - pcs	
TEC 169	20	90	-	-	100 pz - pcs	

Bumpers / Bumpers



Sono usati come paracolpi e protezioni dove è richiesta pulizia e sicurezza.

Used as shock-absorbers and protections where cleanliness and safety are requested.



USI supermercati, ospedali, centri per l'infanzia, celle frigorifere, ambienti alimentari.
USES supermarkets, hospitals, childcare centers, cold rooms, food areas.

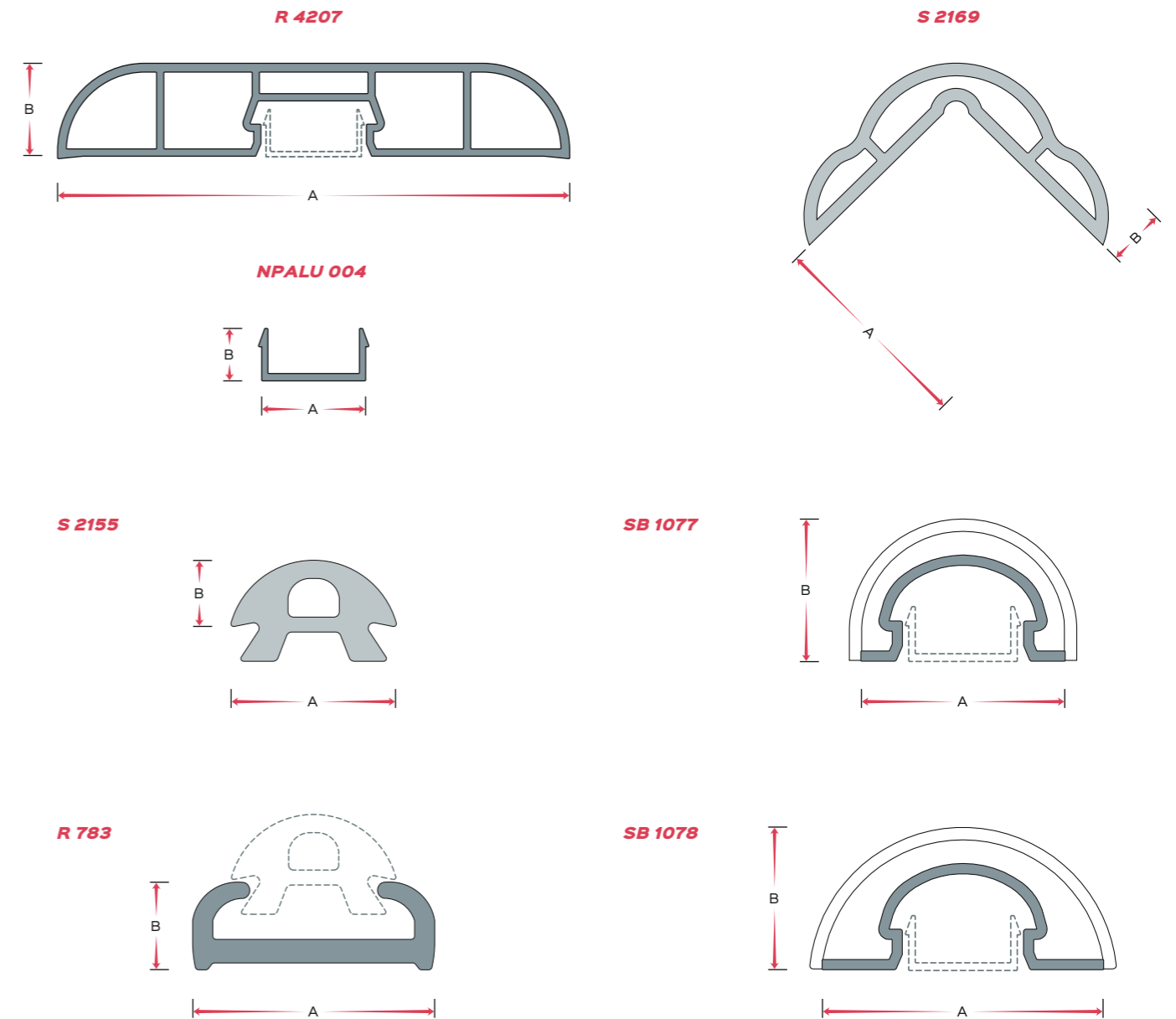

ARTICOLO ITEM	A mm	B mm	MATERIALI MATERIALS	LUNGHEZZA LENGTH mm	COLORI COLORS
R 4207	100	18	PVC	Standard 4000	Standard RAL 9010 RAL 9002
NPALU 004	20	10	Aluminium		
S 2155	30	12	Soft PVC		
R 783	36	13	PVC		
S 2169	30	9	Soft PVC		
SB 1077	38	23	Coextruded PVC		
SB 1078	50	23	Coextruded PVC		
TEC 103	Chiusura per / End cap for: R 4207		PP		
TEC 104	Raccordo angolo / End cap for: R 4207		PP		
TEC 105	Chiusura per / End cap for: S 2155		PP		
TEC 170	Chiusura per / End cap for: S 2169		PP		
TEC 182	Chiusura per / End cap for: SB 1078		PP		
TEC 183	Raccordo angolo / End cap for: SB 1078		PP		
TEC 184	Chiusura per / End cap for: SB 1077		PP		
TEC 185	Raccordo angolo / End cap for: SB 1077		PP		

Tubi e distanziali per pannelli e pavimenti

Tubes and spacers for panels and floors



ARTICOLO ITEM	DIAMETRO mm DIAMETRO mm	FORO mm HOLE mm	LUNGHEZZA STANDARD mm STANDARD LENGTH mm	COLORI COLORS
TR 006	8	4	4000	Standard RAL 9010 RAL 9002
TR 019	14	5	4000	
TR 020	15	5	4000	
TR 022	10	6	4000	
TR 034	12	6	4000	
TR 037	10	3	4000	

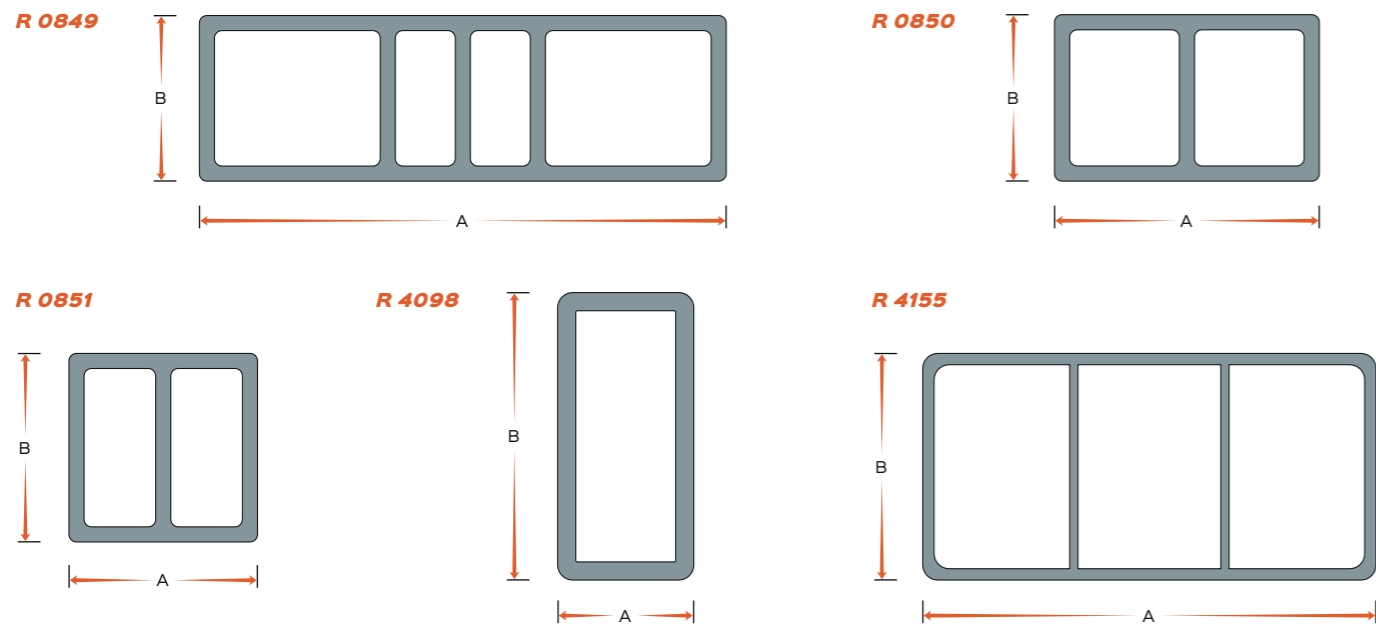

ARTICOLO ITEM	A mm	B mm	LUNGHEZZA LENGTH mm	COLORI COLORS
R 0849	70	22	Standard 4000	Standard RAL 9010 RAL 9002
R 0850	35	22		
R 0851	25	25		
R 4098	38	18		
R 4155	60	30		

USI celle frigorifere, ambienti a temperatura controllata.
USES cold rooms, controlled temperature rooms.

Profili portaprezzi / Price holders profiles

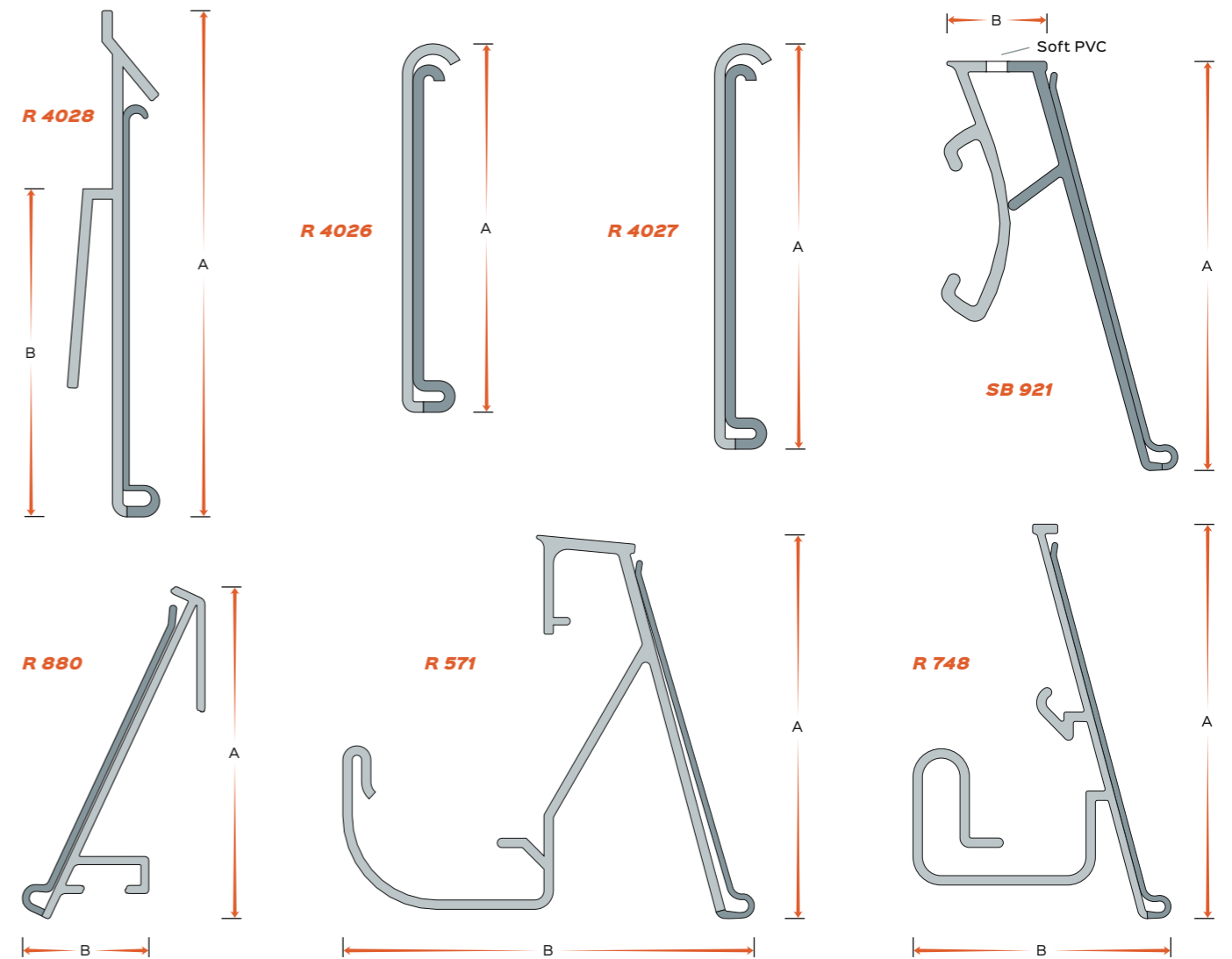

ARTICOLO ITEM	A mm	B mm	LUNGHEZZA LENGTH mm	COLORI COLORS
R 4028	40	30	A richiesta Custom	Standard RAL 9010 RAL 9002
R 4026	35	-		
R 4027	39	-		
SB 921	39	9,6		
R 571	41	44		
R 748	40	27		
R 880	50	-		

USI supermercati.
USES supermarkets.

Guarnizioni per banchi e vetrine Gasket for cabinets and display

Lombardini produce guarnizioni su richiesta del cliente, oltre a fornire profili standard.
Lombardini produces custom profiles, further to standard profiles.

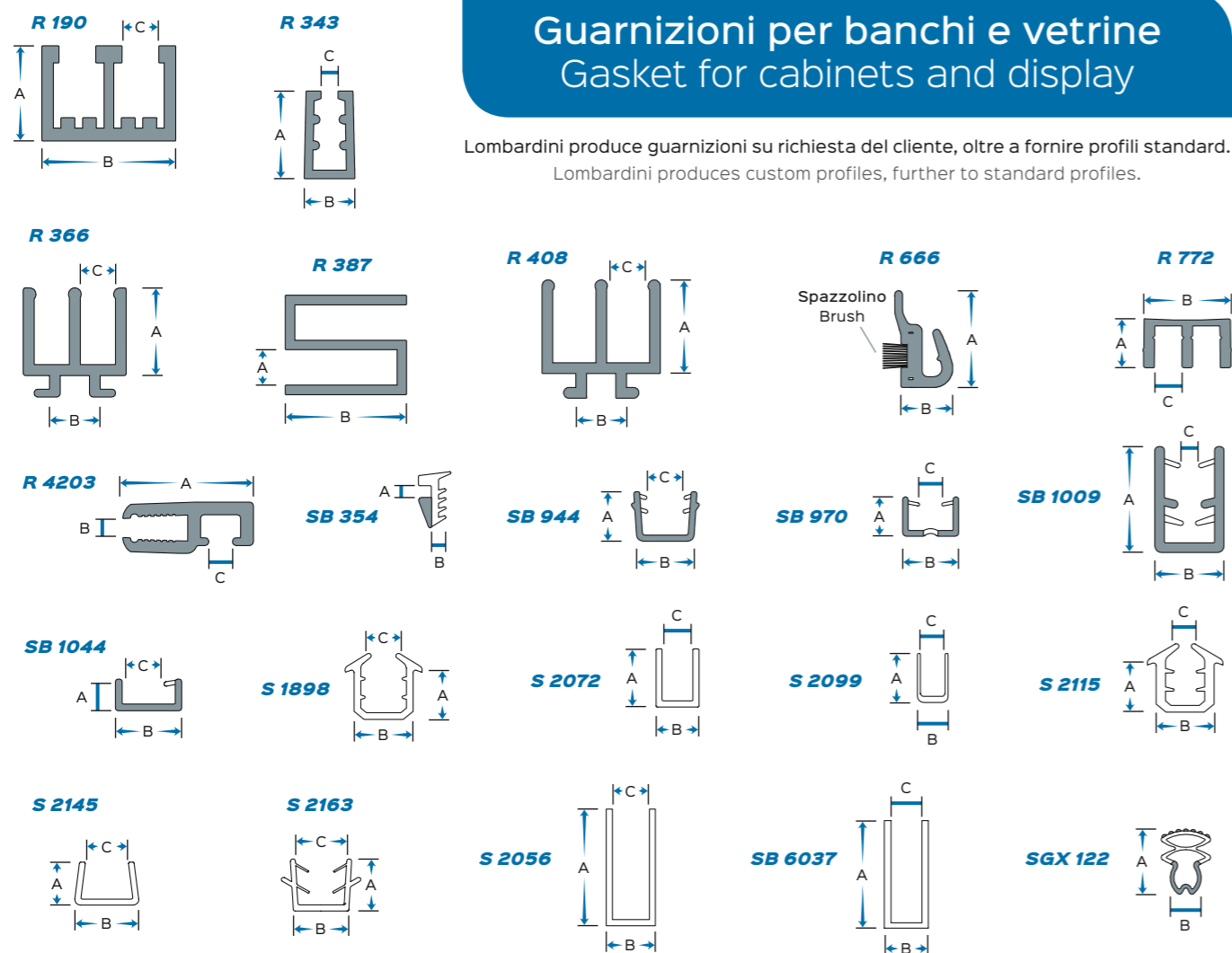

ARTICOLO ITEM	A mm	B mm	C mm	LUNGHEZZA LENGTH mm	COLORI COLORS
R 190	15,2	21,5	6	Standard 3000	Standard RAL 9010 RAL 9002
R 343	14	8	3		
R 366	14	8	6		
R 387	6	19,5	-		
R 408	15	8	6		
R 666	15,5	8,2	-		
R 772	7,7	14	4,75		
R 4203	21	3,4	4,1		
SB 354	2	2,4	-		
SB 944	7,8	9	5		
SB 970	6,3	9	3,6		
SB 1009	17	11	4		
SB 1044	4,9	10,5	6,9		
S 1898	8	9,6	6		
S 2072	9,5	7	5		
S 2099	8	5	4		
S 2115	8	9,4	3,6		
S 2145	7	10,4	7		
S 2163	8,5	9	3,5		
S 2056	19	8	6		
S 6037	17,5	7,2	5		
SGX 122	10,5	5	-		



LOMBARDINI SRL

Via Simone da Corbetta, 158 - 20011 Corbetta (MI) - Italy
Tel.+39 02 97 21 851 - Fax +39 02 97 27 23 22
vendite@lombardinisrl.com - estero@lombardinisrl.com
www.lombardinisrl.com